

carbatec



2YR
WARRANTY

OWNERS MANUAL

317mm Professional Benchtop Thicknesser

TH-B317P

GENERAL SAFETY

NOTE: The **[WARNING!]** and **[CAUTION!]** symbols indicate a potentially hazardous situation which, if not avoided, COULD result in death or serious injury. READ THIS MANUAL completely before assembling and operating this machine.

[WARNING!] TO AVOID serious injury, death, or damage to the machine, please read, understand, and follow, all Safety and Operating Instructions before assembling and operating this machine. This manual is not totally comprehensive. It does not and cannot convey every possible safety and operational problem that may arise while using this machine. The manual will cover many of the basic and specific safety procedures needed in a workshop and industrial environment.

All federal and state laws, and any regulations having jurisdiction covering the safety requirements for use of this machine, take precedence over the statements in this manual. Users of this machine must adhere to all such regulations.

[WARNING!] Exposure to the dust created by power sanding, sawing, grinding, drilling and other construction activities may cause serious and permanent respiratory or other injury, including silicosis (a serious lung disease), cancer, and death. Avoid breathing the dust, and avoid prolonged contact with dust.

Some examples chemicals and toxins you could be exposed to (but not limited to) are:

- Lead from lead-based paints.
- Crystalline silica from bricks, cement and other masonry products.
- Arsenic and chromium from chemically treated timber and
- Asbestos residue from reclaimed timbers

Always operate tool in well-ventilated area and provide for proper dust removal. Use a dust collection system along with an air filtration system whenever possible. Always use properly fitting AS/NZS approved respiratory protection

appropriate for the dust exposure, and wash exposed areas with soap and water.

[WARNING!] ALWAYS wear eye protection. Any machine can throw debris into the eyes during operations, which could cause severe and permanent eye damage. Everyday eyeglasses are NOT safety glasses. ALWAYS wear Safety Goggles (that comply with applicable Australian Standards/New Zealand Standards, referred to as AS/NZS) when operating power tools.

[WARNING!] ALWAYS wear hearing protection. Hearing equipment should comply with appropriate AS/NZS.

[WARNING!] ALWAYS wear a AS/NZS approved dust mask to prevent inhaling dangerous dust or airborne particles.

ALWAYS keep the work area clean, well lit, and organized. DO NOT work in an area that has slippery floor surfaces from debris, grease, and wax.

[CAUTION!] ALWAYS unplug the machine from the electrical receptacle when making adjustments, changing parts or performing any maintenance.

AVOID ACCIDENTAL STARTING. Make sure that the power switch is in the "OFF" position before plugging in the power cord to the electrical receptacle.

[WARNING!] AVOID a dangerous working environment. DO NOT use electrical tools in a damp environment or expose them to rain or moisture.

[WARNING!] CHILDPROOF THE WORKSHOP AREA by removing switch keys, unplugging tools from the electrical receptacles, and using padlocks to lock out machinery, where applicable.

[CAUTION!] DO NOT use electrical tools in the presence of flammable liquids or gasses.

DO NOT FORCE the machine to perform an operation for which it was not designed. It will do a higher quality job, with less effort and safer, by only performing operations for which the machine was intended.

[WARNING!] DO NOT stand on a machine. Serious injury could result if it tips over or you accidentally contact any moving part.

DO NOT store anything above or near the machine.

[WARNING!] DO NOT operate any machine or tool if under the influence of drugs, alcohol, or medication.

Prior to operation EACH AND EVERY time, check for damaged parts prior to using any machine. Carefully check all guards to see that they operate properly, are not damaged, and perform their intended functions.

Check for alignment, binding or breakage of all moving parts. Any guard or other part that is damaged should be immediately repaired or replaced.

[WARNING!] Only connect a machine to a receptacle appropriate for the standard fitted plug and lead. Do NOT modify or replace a machine electrical component, with a lesser-rated or sub-standard component.

[CAUTION!] Keep visitors and children away from any machine. DO NOT permit people to be in the immediate work area, especially when the machine is operating.

KEEP protective guards in place and in working order.

[CAUTION!] MAINTAIN your balance. DO NOT extend yourself over the tool. Wear oil resistant rubber soled shoes. Keep floor clear of debris, grease, and wax.

MAINTAIN all machines with care. ALWAYS KEEP machine clean and in good working order. KEEP all blades and tool bits sharp.

NEVER leave a machine running, unattended. Turn the power switch to the OFF position. DO NOT leave the machine until it has come to a complete stop.

REMOVE ALL MAINTENANCE TOOLS from the immediate area prior to turning the machine ON.

[WARNING!] STAY ALERT, watch what you are doing, and use common sense when operating any machine. DO NOT operate any machine tool while tired or under the influence of drugs, alcohol, or medication. A moment of inattention while operating power tools may result in serious personal injury.

[WARNING!] USE ONLY recommended accessories. Use of incorrect or improper accessories could cause serious injury to the operator and cause damage to the machine. If in doubt DO NOT operate it.

THE USE of long extension cords is not recommended for 230V equipment. It is better to arrange the placement of your equipment and the installed wiring to eliminate the need for an extension cord. If an extension cord is necessary, seek qualified advice to determine the minimum gauge for the extension cord based on the length being used. The extension cord must also contain a ground wire and plug pin.

[CAUTION!] Wear proper clothing, DO NOT wear loose clothing, gloves, neckties, or jewelry. These items can get caught in the machine during operations and pull the operator into the moving parts. Users must wear a protective cover on their hair, if the hair is long, to prevent it from contacting any moving parts.

SAVE these instructions and refer to them frequently and use them to instruct other users.

NOTE: Information regarding the safe and proper operation of machinery and power tools is also available from the following source:

Safe Work Australia

www.safeworkaustralia.gov.au

GENERAL SAFETY INSTRUCTIONS

1. Serious personal injury may occur if normal safety precautions are overlooked or ignored. Accidents are frequently caused by lack of familiarity or failure to pay attention. Obtain advice from supervisor, instructor, or another qualified individual who is familiar with this machine and its operations.
2. Every work area is different. Always consider safety first, as it applies to your work area. Use this machine with respect and caution. Failure to do so could result in serious personal injury and damage to the machine.
3. To help prevent electrical shock, always follow all electrical and safety codes, including the AS/NZS Electrical Standards and the relative Workplace/Occupational Health and Safety and Regulations. All hard

wired electrical connections, repairs and wiring should be made by qualified personnel only.

4. **[WARNING!]** TO REDUCE the risk of electrical shock. DO NOT use this machine outdoors. DO NOT expose to rain. Store indoors in a dry area.
5. STOP using this machine, if at any time you experience difficulties in performing any operation.
6. Safety decals are on this machine to warn and direct you to how to protector yourself or visitors from personal injury. These decals MUST be maintained so that they are legible. REPLACE decals that are not legible.
7. DO NOT leave the unit plugged into the electrical outlet. A good work practice is to unplug the unit from the outlet when not in use and before servicing, performing maintenance tasks, or cleaning.
8. **[WARNING!]** DO NOT handle the plug or operate the machine with wet hands
9. USE only parts or accessories as described in this manual and recommended by Carbatec.
10. DO NOT pull the machine by the power cord. NEVER allow the power cord to come in contact with sharp edges, hot surfaces, oil or grease.
11. ALWAYS turn the power switch "OFF" before unplugging the machine. DO NOT unplug the machine by pulling on the power cord. ALWAYS grasp and pull by the plug end when removing from a power receptacle.
12. REPLACE any damaged cord and plug immediately. DO NOT operate with a damaged cord or plug and have it replaced by a qualified person.
13. DO NOT use machinery as a toy. DO NOT use near or around children.
14. ENSURE that the machine sits firmly before using. If the machine wobbles or is unstable, correct the problem by attaching to a bench top or suitable work platform, prior to operation.

15. This machine is designed for the processing of wood only. DO NOT use with other materials.
16. **[WARNING!]** NEVER position fingers, thumbs or any part of your body, near the cutterhead or blade.
17. Long pieces of stock should ALWAYS be supported with some type of fixture.
18. DO NOT operate machinery with dull or damaged blades.
19. MAKE CERTAIN that the machine is properly adjusted prior to use.

SPECIFIC SAFETY INSTRUCTIONS

1. DO NOT try and remove excessive amounts of wood in one single pass.
2. INSPECT all stock before beginning operations ensuring that there are no foreign objects embedded in the wood, loose knots, or knots that may become loose during operation.
3. **[WARNING!]** DO NOT attempt to remove jams until power is disconnected and all moving parts have come to a complete stop.
4. MAKE SURE that there is adequate operating space on both the in-feed and out-feed sides of the thicknesser before operating.
5. DO NOT attempt to machine wood that is less than 200mm long or less than 6mm thick. The use a scrap board of same thickness to follow shorter boards, and use a 'sled' for thinner boards may help.
6. Ensure adequate dust extraction is connected to the thicknesser while it is in operation.

UNPACKING AND INVENTORY

Check shipping carton and machine for damage before unpacking. Carefully remove packaging materials, parts and machine from shipping carton. Always check for and remove protective shipping materials around motors and moving parts. Lay out all parts on a clean work surface.

Remove any protective materials and coatings from all of the parts and the planer. The protective coatings can be removed by spraying WD-40 on them and wiping it off with a soft cloth. This may need to be redone several times before all of the protective coatings are removed completely.

After cleaning, apply a good quality paste wax to any unpainted surfaces including the infeed, outfeed, and center tables. Make sure to buff out the wax before assembly.

Compare the items to inventory figures and verify that all items are accounted for. If at all possible, retain shipping carton for warranty service if ever needed.

If any parts are missing, do not attempt to plug in the power cord and run the machine. The machine should only be turned "ON" after all the parts have been obtained and installed correctly.

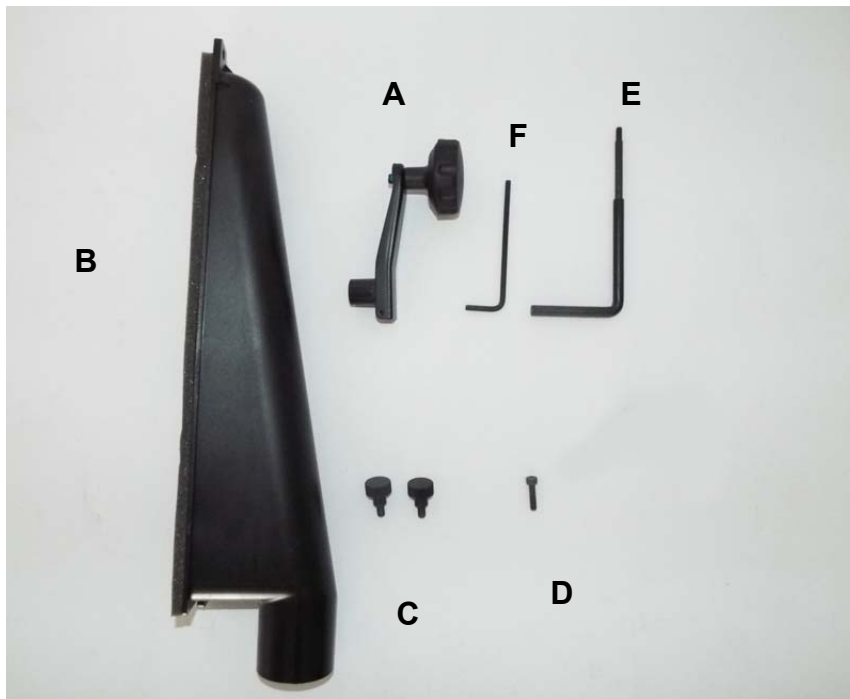

- | | | | |
|----|----------------------------|----|--------------|
| A. | Raise / Lower Handle | D. | Handle Screw |
| B. | Dust Port | E. | Torx Wrench |
| C. | Dust Chute Thumb Screw (2) | F. | Hex Wrench |

ASSEMBLY

WARNING! MAKE CERTAIN THAT THE MACHINE IS DISCONNECTED FROM THE POWER SOURCE.

ATTACHING DEPTH ADJUSTMENT HANDLE

Attach the raise/lower adjustment handle (A) to the shaft (B) and fasten in place with 1 Hex Socket Head screw. Tighten screw using supplied hex wrench. SEE FIG 1.

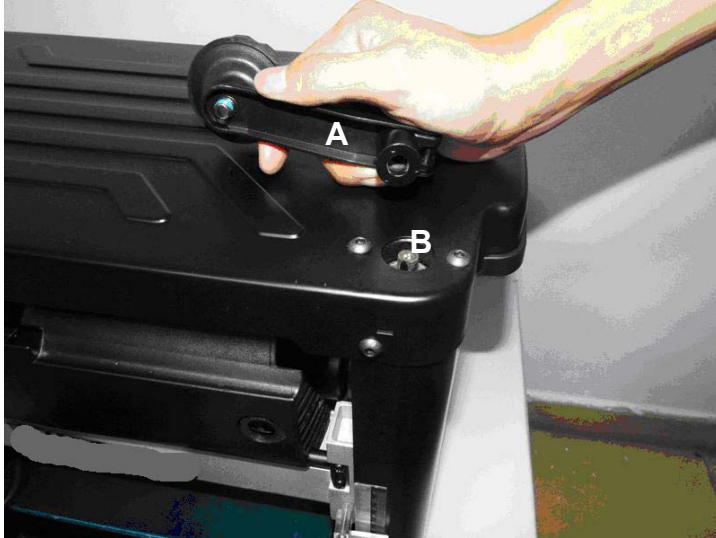

FIG 1

ATTACHING DUST PORT

The Dust Port is to be used when the planer to be connected to a dust collector. It has a 2" port on it to accommodate dust collection systems.

To install:

1. Install the dust port (A) in the rear of the planer by using 2 thumb screws (B). SEE FIG 2

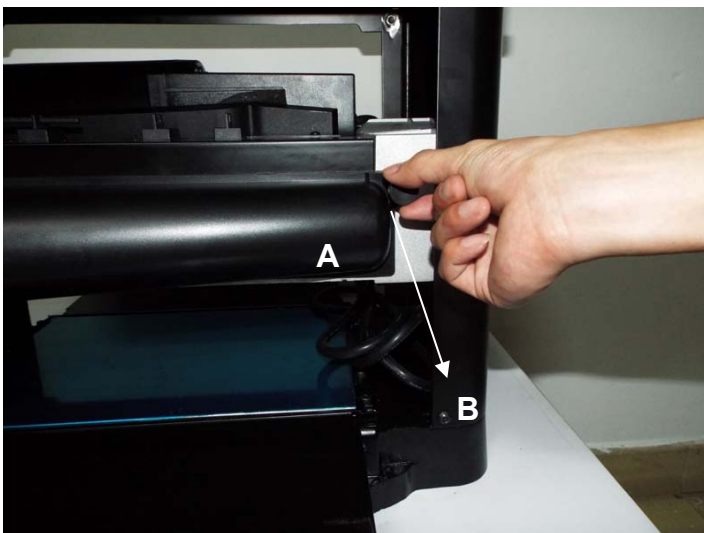

FIG 2

ASSEMBLY (Cont)

SECURING PLANER TO A TABLE OR WORKBENCH

During operation, if there is any tendency for the planer to tip over, slide or walk, the planer **MUST** be secured to a supporting surface such as a workbench or table. Four holes are provided (2 are shown at (A)) to securely mount the planer. The surface you are mounting the planer to should be perfectly flat. SEE FIG 3.

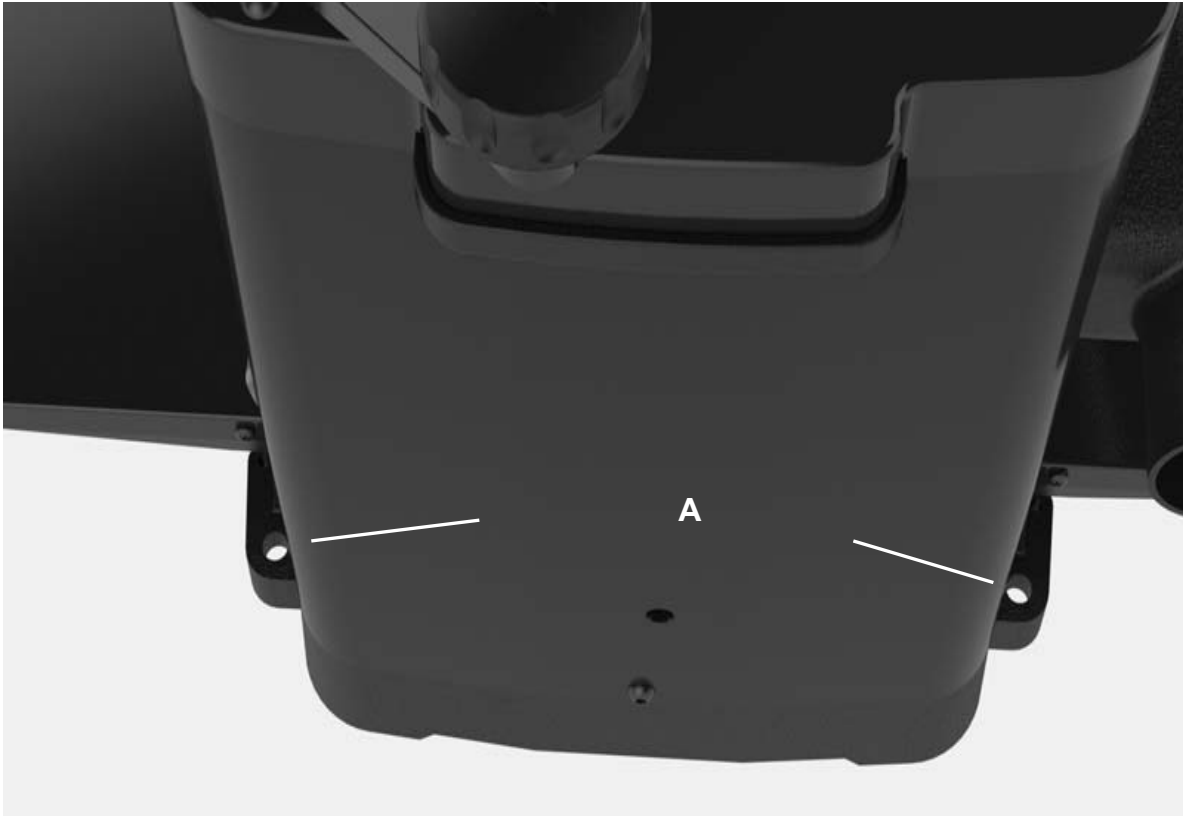

FIG 3

ADJUSTMENTS

WARNING! MAKE CERTAIN THAT THE MACHINE IS DISCONNECTED FROM THE POWER SOURCE BEFORE ANY ADJUSTMENTS ARE MADE.

LEVELING EXTENSION TABLES

The extension tables must be level with the planer table. To check the extension tables and adjust if necessary:

1. Lay a straight edge (A) on the planer table (C) with one end of the straight edge over the infeed table (B). SEE FIG 4.
2. Check to make sure that the infeed table is level with the planer table.
3. If an adjustment is necessary, raise table, loosen lock nuts (D) and adjust Hex Head Screws (E) on each side of the table until the infeed table is level with the planer table. This will adjust the outer edge of the table. If necessary, loosen the two screws of one side of infeed table (F), after adjusting, then retighten the screws back. Adjust another side of infeed table in the same manner.
4. Recheck for level and repeat adjustment if necessary.
5. Repeat this process for leveling the outfeed table.

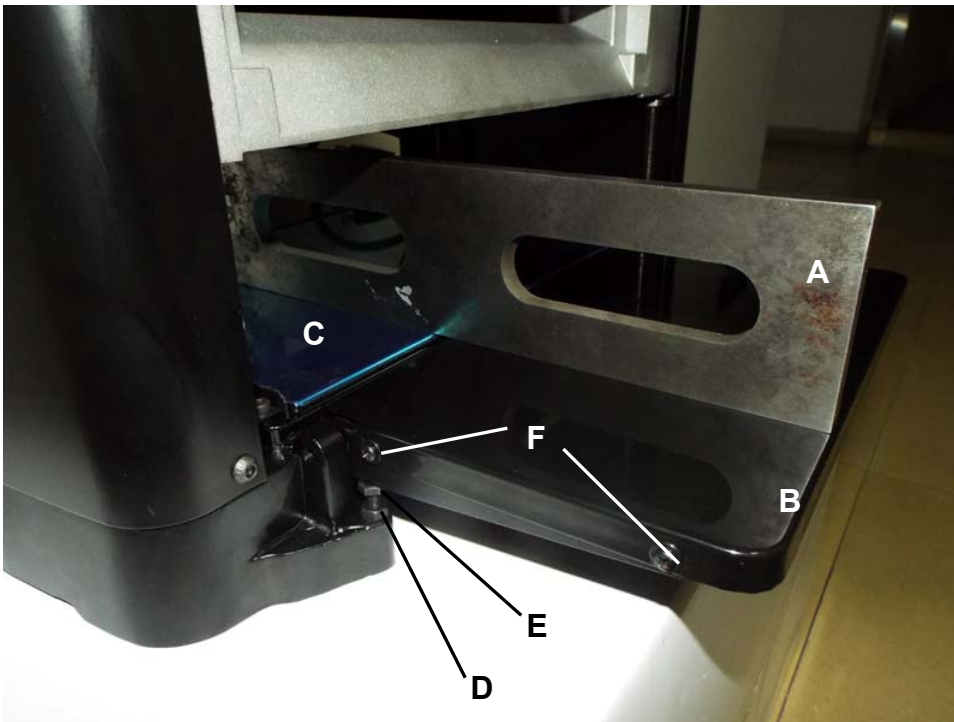

FIG 4

ADJUSTMENTS (Cont)

RAISING AND LOWERING HEAD ASSEMBLY

The head assembly consists of the cutterhead, knives, feed rollers, cutterhead guard, and the motor. Raising and lowering of the head assembly controls the depth of cut on the planer.

To adjust:

1. To raise the head assembly (A), turn the adjusting handle (B) clockwise. SEE FIG 5.
2. To lower the head assembly, turn the adjusting handle counterclockwise.

NOTE: One revolution of the handle will move the cutterhead up or down approximately 1/16". You can confirm this by referencing the scale (C) on the front right side of the planer.

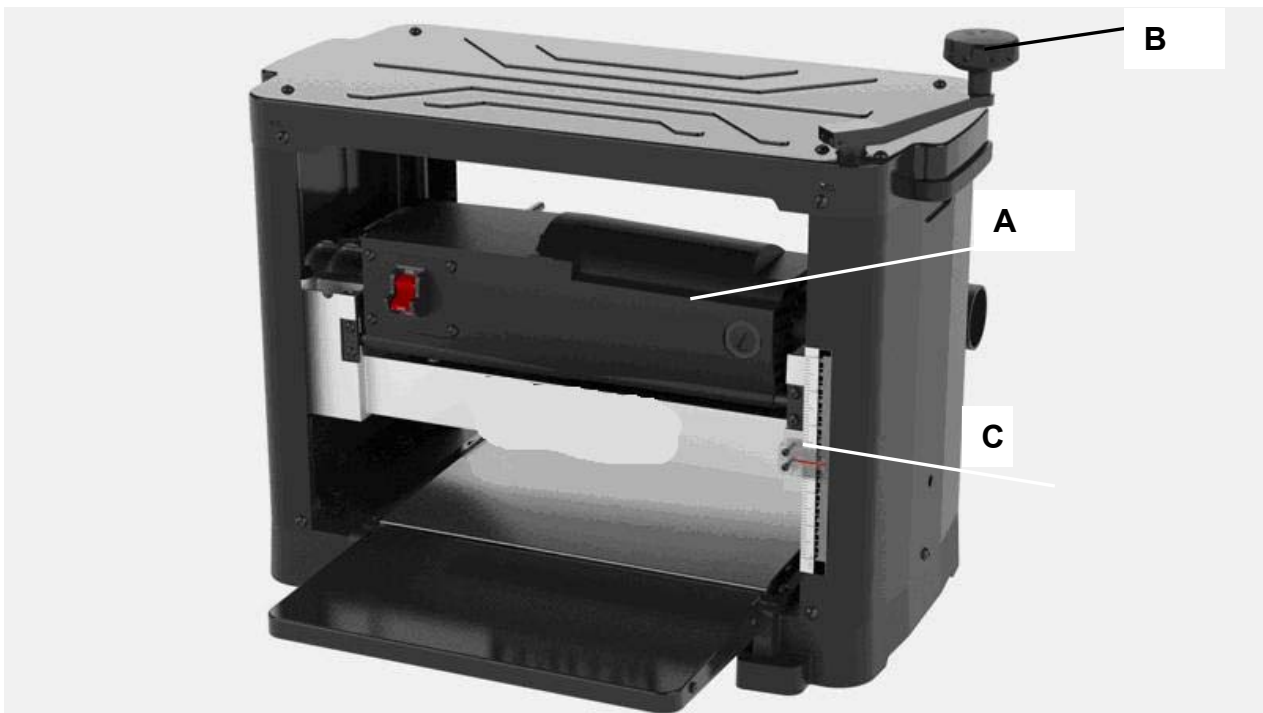

FIG 5

ADJUSTMENTS (Cont)

WARNING! MAKE CERTAIN THAT THE MACHINE IS DISCONNECTED FROM THE POWER SOURCE BEFORE ANY ADJUSTMENTS ARE MADE.

WARNING! *** Be VERY CAREFUL when handling the knives or cutter tips as they are EXTREMELY SHARP and can cause serious injury!!! ***

WARNING! NEVER GRASP THE CUTTERHEAD BY HAND!

The knives supplied with the planer have an edge on both sides of the blade enabling you to flip the knives over when one edge becomes dull or pitted. To change:

1. The knife removal tool (A) is supplied with your planer and attached underneath the outfeed table (B) with Velcro (C), you can store the tool when it's not in use. SEE FIG 6 on the following page.
2. Use the raise/lower handle to lower the cutterhead assembly down to 1".
3. Remove the cutterhead guard (A) by removing the thumb screws (B). SEE FIG 7 on the following page.
4. Rotate the cutterhead with the supplied Hex wrench (A). Rotate the cutterhead using the wrench to the position where the sharp edge of the blade is not visible from your sight angle. SEE FIG 8 on the following page.
5. Using the supplied torx wrench (B), unscrew the six screws (C) just enough so that the locking bar (D) separates from the knife (E), allowing the knife to be removed. Do not completely remove the screws. Insert the magnetic knife removal tool (F) underneath the center of the locking bar. SEE FIG 8 & 9 on the following page.
6. Lift the tool up until the knife separates from the pins and remove the knife.
7. Rotate the knife 180 degrees so that the edge of the knife that was facing you is now facing away from you and reinsert the knife. If you have already used both edges of the knife, replace the knife at this time.
8. Place the magnetic knife removal tool on top of the knife. Make sure that the tool is centered on the knife.
9. Place the knife on the pins in the cutterhead and remove the knife removal tool.
10. Retighten the six screws that were loosened in step 5 above.
11. Repeat this process for the remaining knife.

NOTE: When placing the knives on the pins, you will notice that there is some slight side to side movement available in the knife. This is normal as it allows for repositioning of the knives in case one of the knives gets a nick in it.

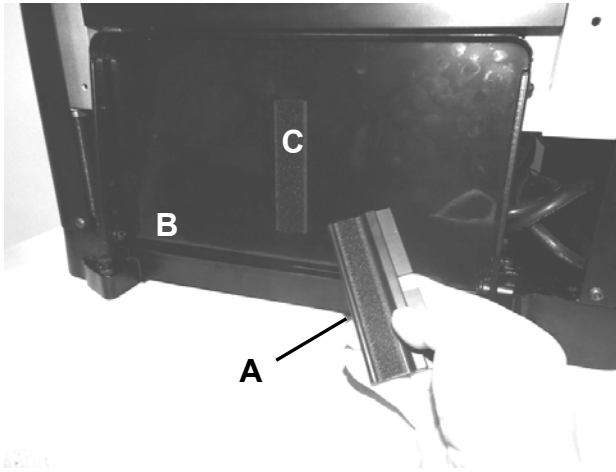

FIG 6

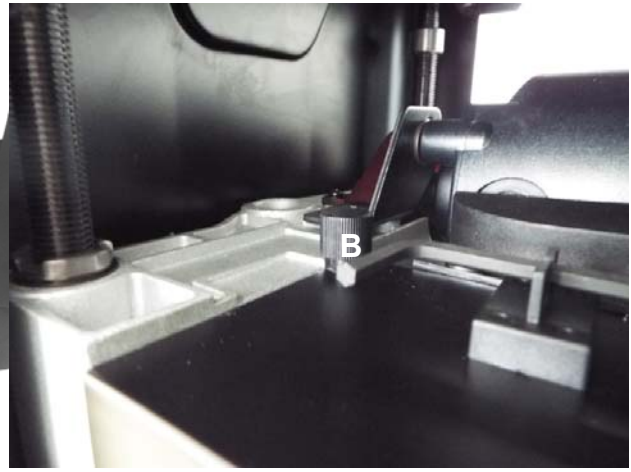

FIG 7

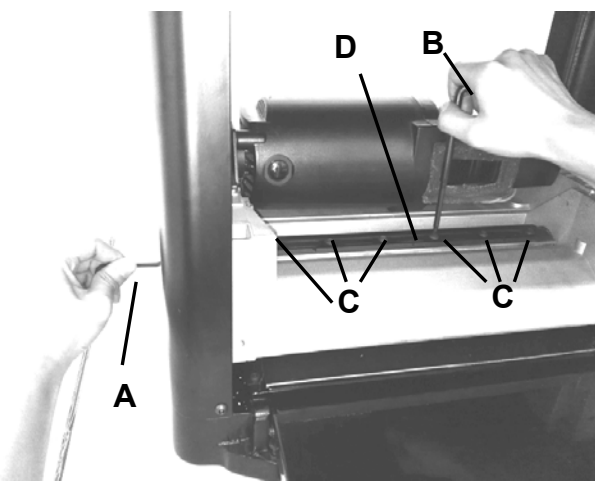

FIG 8

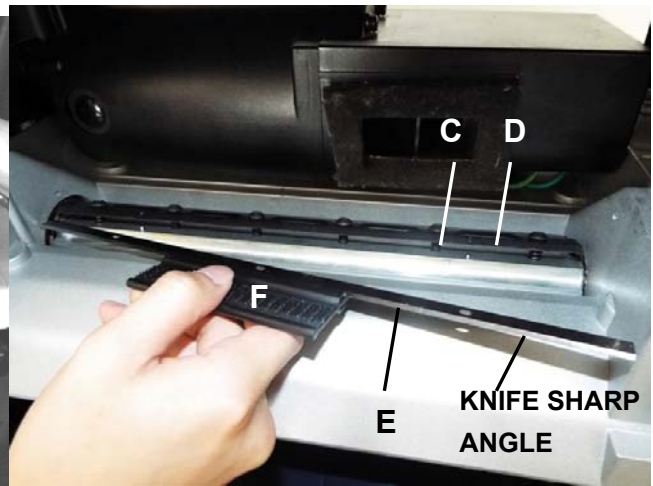

FIG 9

THICKNESS SCALE ADJUSTMENT

The thickness scale, located on the right of the planer, shows the thickness of the finished workpiece. To make sure the scale is set properly, run a piece of wood through the planer and measure the thickness of the wood. If the scale is out of alignment, loosen the two round head screws (A) holding the scale indicator (B) and adjust the thickness indicator to the correct setting. Make sure to re-tighten the two screws once the adjustment is complete. FIG 10

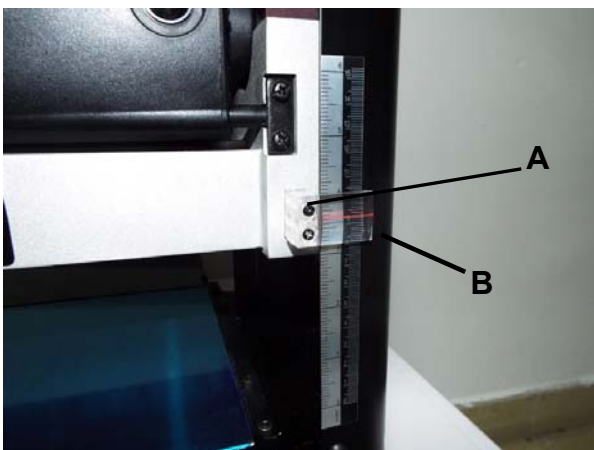

FIG. 10

OPERATIONS

NOTE: This operations section was designed to give instructions on the basic operations of this planer. However, it is in no way comprehensive of every planer operation. It is strongly recommended that you read books, trade magazines, or get formal training to maximize the potential of your planer while minimizing the risks.

NOTE: This planer is designed to process wood ONLY.

WARNING! Make sure the switch is in the "OFF" position before connecting cord into socket. Do not touch the plug's prongs when unplugging or plugging.

WARNING! In the case of a power outage (such as a breaker or fuse trip), always turn the switch to the "OFF" position until the power is restored.

The machine is fitted with a No Volt Release (NVR) safety switch. The NVR switch can only be activated if the machine is connected to mains power. During operation, any disruption to the mains power supply will see the this NVR switch release, preventing the machine restarting automatically. The user will need to physically re-start the unit after the cutterhead has come to a complete stop.

The jointer is started on by pressing the green ON button. In regular operation, the machine is switched off, by pressing the RED stop button.

OPERATIONS

GETTING PREPARED

It is always a good idea to use a piece of scrap wood for your first planing attempt. Also, before each use of the planer, make it a habit of checking for loose fasteners, fittings or hardware. Turn the planer ON and allow it to reach full speed. Pay close attention to any excessively loud noises that may be coming from the planer or any excessive vibration. If either occurs, shut down the planer immediately checking again for loose hardware. Go through the ASSEMBLY and ADJUSTMENTS sections again if necessary.

BASIC OPERATION

WARNING! To avoid serious personal injury, NEVER stand directly in line with the front or rear of the planer. If an object is thrown from the planer, it will travel in this direction.

1. Stand to either the left or right side of the planer.
2. Turn the switch to the ON position.
3. Lift the workpiece onto the infeed table by grabbing the edges of the board at the middle of the length. NOTE: For longer pieces, be sure to use additional supports or stands.
1. Push slightly on the board to start feed and allow the feed rollers to pull the board through the planer. Once the feed rollers start to pull the workpiece through, let go of the board and allow the rollers to do their job. DO NOT push or pull on the workpiece once the rollers have engaged.
2. Move to one side of the rear of the planer and receive the planed workpiece by grabbing the edges of the wood like you did when feeding the workpiece in.
6. It normally takes several passes of varying depths to achieve a smooth finish, so repeat this process as many times as necessary. Remember the less you take off in a pass, the smoother the finish will be. Finish the surface by sanding.

THICKNESS PLANING

Thickness planing sizes the workpiece to a desired thickness, while at the same time creating a smooth and level surface. The thickness of each cut will depend on the type of wood, width of the workpiece, and condition of the lumber (i.e. dryness, grain composition, straightness, etc). Always make thin test cuts on a scrap piece of wood prior to performing final cuts.

GENERAL TIPS AND GUIDELINES

1. Thickness planing always works best when at least one side of the workpiece has a flat surface. If both sides of the workpiece are rough, feed one face of the board through the planer until the entire surface is flat.
2. ALWAYS plane both sides of the workpiece to reach the desired thickness.
3. DO NOT plane workpieces less than 3/16-in thick, less than 3/4-in wide, or shorter than 7-in.
4. It is not recommended to continuously use the planer at its maximum depth of cut (1/16") and at its full width (12-1/2") as this will shorten the life of the motor.
5. Light cuts create a smoother finish than heavier cuts.
6. If a smooth cut is not obtained, see TROUBLESHOOTING GUIDE on page 24.

OPERATIONS (Cont)

AVOIDING SNIPE

Snipe, gouging or depression of the board at the ends, can occur when the board is not properly supported. For workpieces longer than 4 ft, greater care must be taken to reduce the problem because the additional length of the workpiece translates into more unsupported weight pulling down on the end of the board. This unsupported weight will work against keeping the stock flat. Make sure to use supports or stands whenever long pieces are being planed to avoid this problem. Since snipe occurs at the end of the boards, it is good practice to start with a workpiece that is slightly longer than what you need so that you can simply cut off the ends if necessary. Also see TROUBLESHOOTING for further information.

MAINTENANCE

WARNING! MAKE CERTAIN THAT THE MACHINE IS DISCONNECTED FROM THE POWER SOURCE BEFORE PERFORMING ANY MAINTENANCE PROCEDURES

Your planer should provide you with a long time of service provided you take the time to perform the following maintenance operations.

CLEANING

Sawdust buildup and other debris can cause the tool to plane incorrectly. Periodic cleaning and waxing is needed for accurate, precision planing. Any moving parts should be cleaned regularly with a penetrating oil and lubricated with a light coating of medium weight machine oil

CAUTION! With the machine unplugged, blow off motor with low pressure air to remove dust or dirt. Air pressure above 50 P.S.I. should not be used as high-pressured air may damage insulation. The operator should always wear a respirator and eye protection when using compressed air. Do not allow chips and dust to accumulate under the machine. Keep area clean and in safe order.

Having clean feed rollers is essential for optimal results. Check feed rollers after each use for buildup of pitch, gum, or resin, and be sure to clean off with a non-flammable tar and pitch remover that is not harmful to rubberized surfaces.

Periodically clean, wax, and buff the tables. This will aid in the prevention of improper feeding of the workpiece.

HARDWARE TIGHTNESS

Periodically check all clamps, nuts, bolts, and screws, for tightness and condition. Stop the machine and recheck the cutterhead screw and knives, or tips, for tightness after about 50 hours of operation. Recheck periodically.

MAINTENANCE (Cont)

GEAR LUBRICATION

The gears in the gear box should be lubricated periodically.

1. Facing the front of the machine, remove the raise/ lower handle. SEE FIG. 1 page 13.
2. Remove the 4 screws on the upper sides for holding the top cover on the machine. Remove the top cover.
3. On the left side panel, remove the 3 socket head screws (A) located around the bottom edge and remove the side panel to expose the gearbox cover. SEE FIG 13.

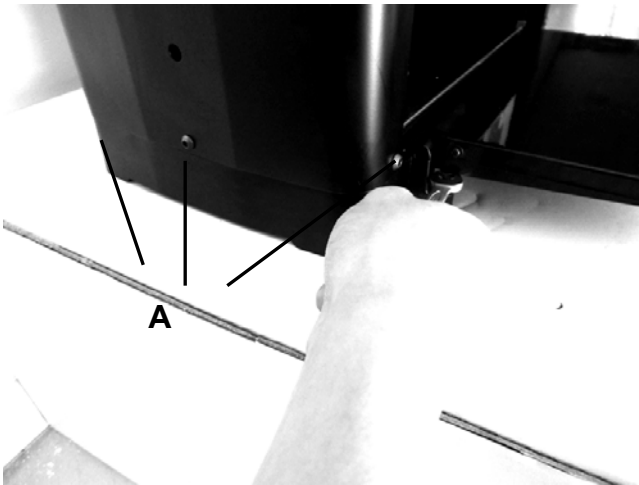

FIG 13

4. Place a light coat of multi-purpose grease on the teeth of the gears (A) and a light coat of spray lubricant on the chain (B). Do not over-lubricate and replace the side panel. SEE FIG 14.



FIG 14

5. Replace all covers, panels and guards, that you removed once lubrication is complete.

MAINTENANCE (Cont)

BRUSH REPLACEMENT

Brush life will vary depending on the load placed on the motor. The brushes should be inspected every 10-15 hours of use. To inspect or replace:

1. Remove the brush holders, one of which is shown at (A). The other is located in the same position on the rear of the motor assembly. The Brush Holder can be removed using a flat blade screwdriver. SEE FIG. 15.

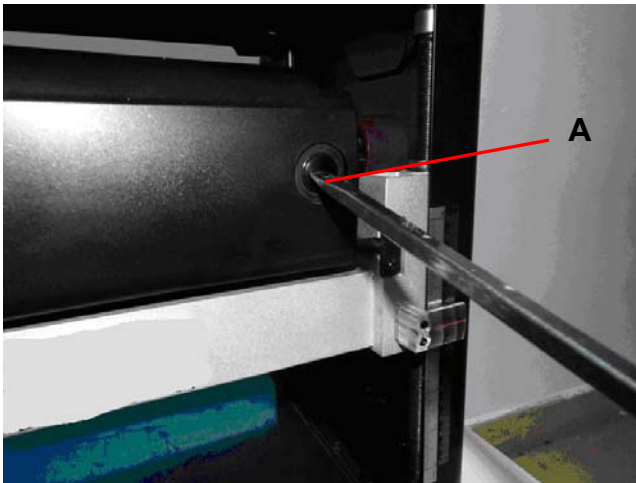

FIG 15

2. Once the brush has been removed, inspect the carbon (B), the spring (C), and the wire (D). SEE FIG 16.

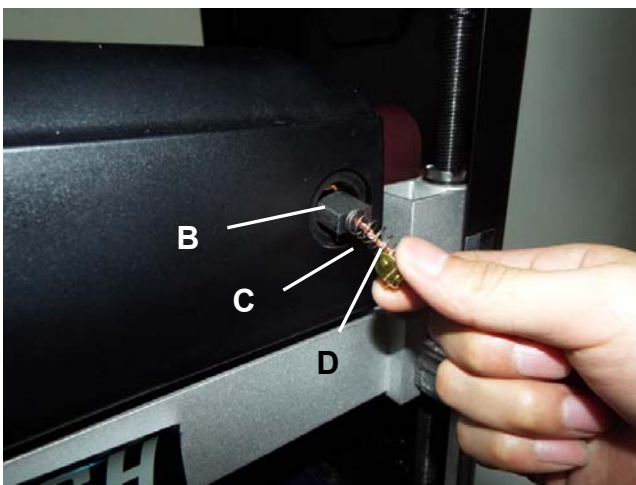

FIG 16

3. If the carbon of either brush is worn down to 3/16" or less, both brushes should be replaced. Also if the spring or wire are burned or damaged in any way, both brushes should be replaced.

TROUBLESHOOTING GUIDE

Motor and Machine Operation

PROBLEM	LIKELY CAUSE	SOLUTION
Snipe (depressions at end of workpiece)	Dull Blades Infeed or outfeed tables out of adjustment. Residue on rollers.	Replace or turn blades. Readjust tables. Feed scrap of same thickness before and after workpiece. Clean rollers.
Torn grain.	Too deep or shallow blade setting. Work piece being fed against grain. Dull cutter blades	Reduce or increase the depth of cut. Feed other end of board first. Replace or turn blades. Try skewing board when feeding. VERY slightly dampen work piece.
Fuzzy/rough grain.	High wood moisture content. Dull blades Too deep a blade setting.	Dry wood before planing. Replace or turn blades Reduce depth of cut
Board thickness does not match depth scale indicator.	Depth scale incorrectly set.	Adjust depth scale.
Will not start.	Not plugged in. Blown circuit. Switch key removed.	Check the power source. Replace fuse, reset breaker, or call electrician. Replace switch key.
Interrupted operation	Unit overloaded. Circuit overloaded.	Reduce load. Operate on circuit separate from other appliances or motors or connect to circuit with adequate amp rating.
Planer not feeding properly	Too much material being removed. Knives or tips dull. Build up on tables. Build up on rollers.	Reduce cut depth. Replace knives or tips. Clean tables and apply paste wax. Clean rollers with a cleaner safe for rubber surfaces.

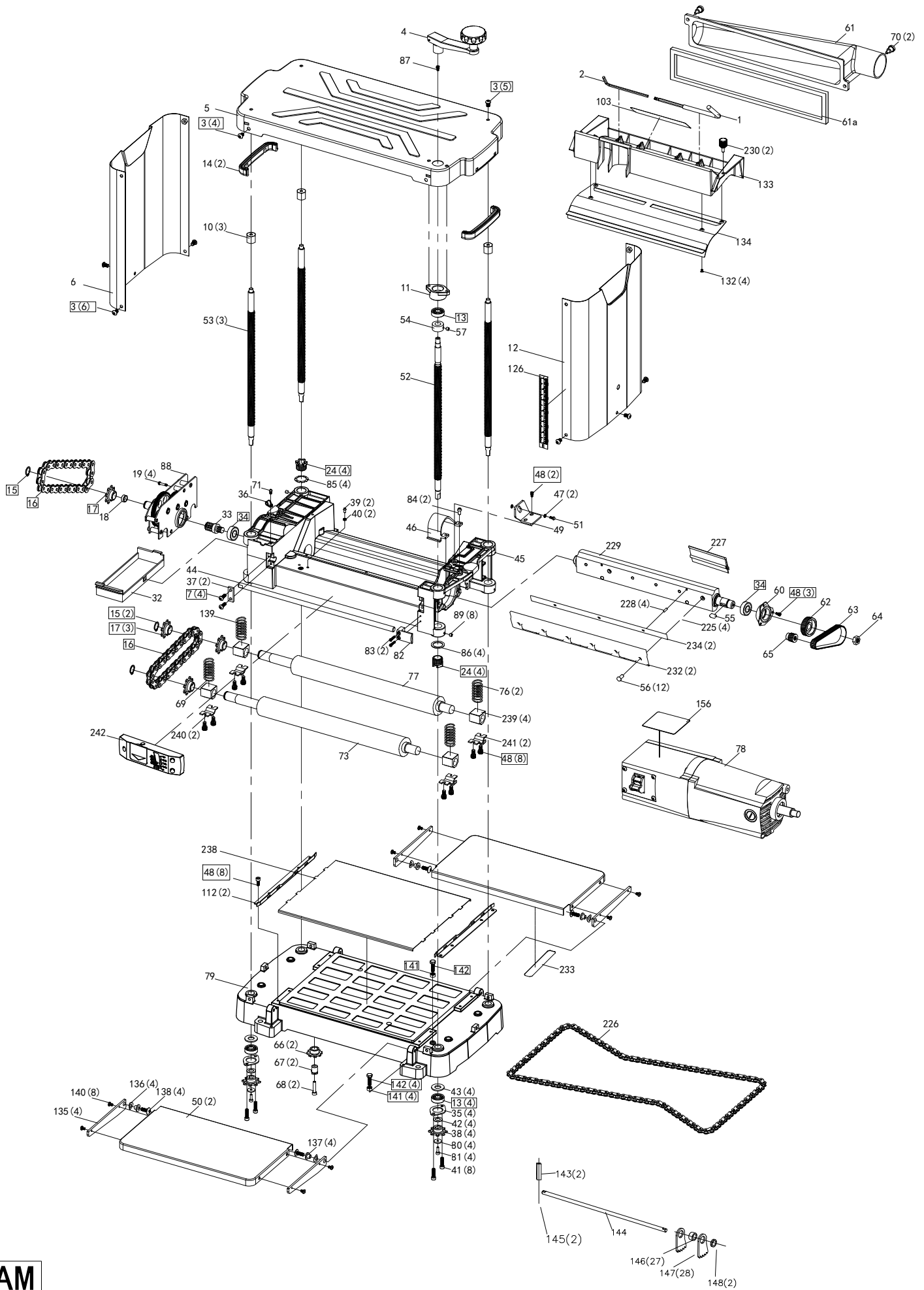

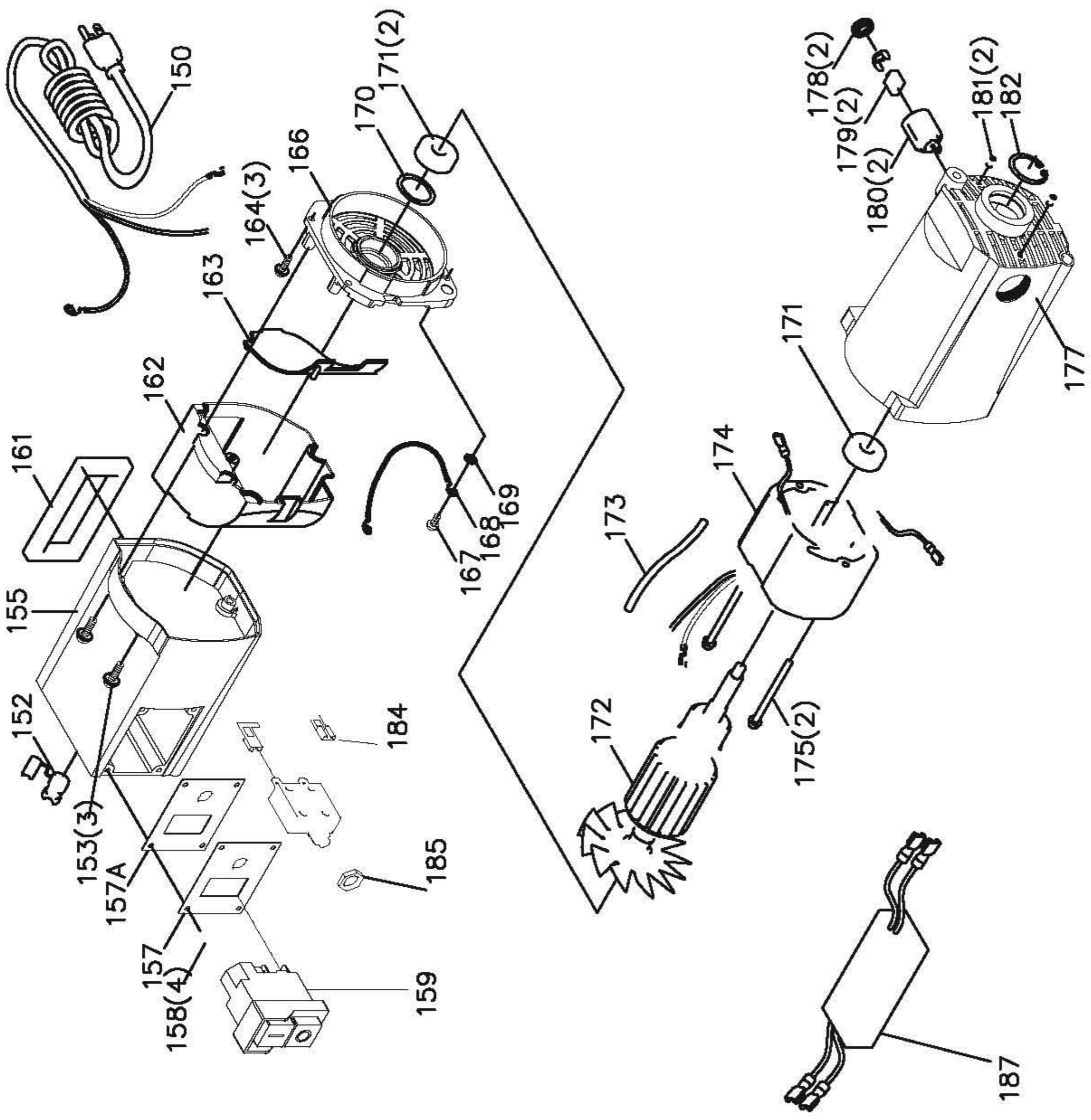
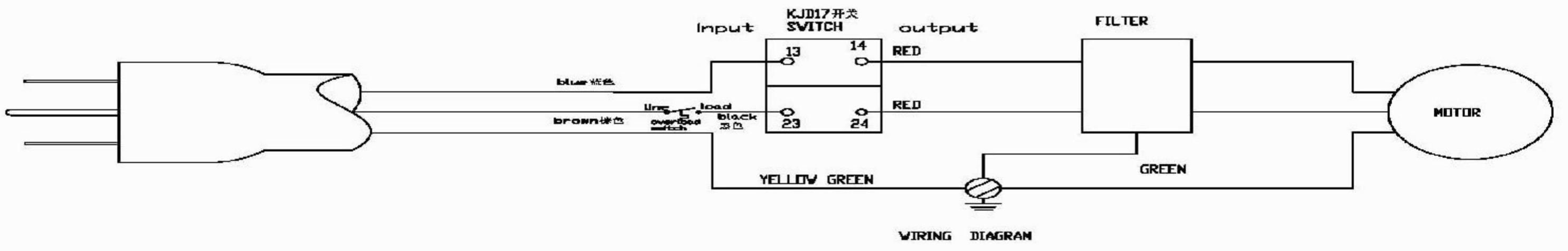

Ser#	Drawing	Description	Spec	QTY
1	40700-001	WRENCH		1
2	40700-002	WRENCH		1
3		HEX SOC HD CAP SCR	M6xP1.0x8L	15
4		HANDLE		1
5	40700-005	TOP COVER		1
6	40700-006	LEFT PANEL		1
7		SCREW	M5XP0.8X12L	4
10	40700-010	SHAFT BUSHING		3
11	40700-011	UPPER BEARING SEAT		1
12	40700-012	RIGHT PANEL		1
13		SPINDLE BEARINGS		5
14	40700-014	HANDLE BAR		2
15		C-RING		3
16	40700-016	CHAIN		2
17	40700-017	SPROCKET		4
18	40700-018	SPACER		1
19		SCREW	M5xP0.8x35L	4
20		SCREW	M5xP0.8x27L	2
22		BEARING		1
23	40700-023	SHAFT		1
24	40700-024	ELEVATION NUT		8
25	40700-025	BUSHING		5
26	40700-026	GEAR		1
27	40700-27a	GEAR		1
28	40700-28a	GEAR		1
29	40700-29	SPACER		4
30	40700-30	SPACER		2
33	40700-33	GEAR		1
34		BEARING		2
35	40700-035	BASE BEARING RETAINER		4
36		CORD CLAMP		1
37	40700-037	PLATE		2
38	40700-038	SPINDLE SPROCKET		4
39		SCREW	M5XP0.8X8L	2
40		WASHER		2
41		SPECIAL HEX SOC HD CAP SCR	M5xP0.8x12L	8
42	40700-042	FLAT WASHER		4
43	40700-043	WASHER		4
44	40700-044	MOTOR PIVOT ROD		1

Ser#	Drawing	Description	Spec	QTY
45	40700-045	UPPER FRAME		1
46	40700-046	BELT COVER		1
47		WASHER		2
48		SCREW	M5xP0.8x12L	21
49	40700-049	MOTOR BRACKET		1
50	40700-050	EXTENSION TABLE		2
51		SCREW	M8xP1.25x16L	1
52	40700-052	HEIGHT ADJ SPINDLE		1
53	40700-053	SPINDLE		3
54	40700-054	SPACER		1
55	40700-055	KEY		1
56	40700-056	TORX SCREW 12PK	M6xP1.0x16L	12
57		NYLOCK SCR SOC SET CUP PT	M5xP0.8x5L	1
60	40700-060	BEARING CAP		1
61	40700-061	DUST PORT		1
62	40700-062	CUTTERHEAD PULLEY		1
63		BELT		1
64	40700-064	BOLT		1
65	40700-065	MOTOR PULLEY		1
66	40700-066	IDLE WHEEL		2
67	40700-067	IDLE WHEEL SHAFT		2
68		HEX SOC HD SCR	M5xP0.8x25L	2
69	40700-069	SPRING		1
70	40700-070	THUMB SCREW		2
71		SCREW	M5xP0.8x12L	1
73	40700-073	INFEED ROLLER		1
76	40700-076	SPRING		2
77	40700-077	OUTFEED ROLLER		1
78		MOTOR		1
79	40700-079	BASE		1
80	40700-080	FLAT WASHER		4
81		NYLOCK HEX SOC HD SCR	M4xP0.7x12L	4
82	40700-082	CURSOR		1
83		PAN HD SCR	M3xP0.5x25L	2
84		SCREW	M4xP0.7x10L	2
85	40700-085	WASHER		4
86		FLAT WASHER		4
87		HEX SOC HD SCR	M5xP0.8x20L	1
88		GEAR BOX		1
89		SCREW	M5xP0.8x6L,SCM3	8

Ser#	Drawing	Description	Spec	QTY
112	40700-112	WEAR PLATE		2
126		SCALE		1
132		SCREW	M4xP1.4x8L	4
133		DUST CHUTE		1
134		DEFLECTOR		1
135	40700-135	EXTENTIONS		4
136	40700-136	WASHER		4
137	40700-137	BUSHING		4
138		PAN HD SCR	M6X16LxP1.0	4
139		SPRING		1
140		SCREW	M4X6L	8
141		BOLT		5
142		SCREW	M6x20L	5
225	40700-225	SPRING		4
226	40700-226	CHAIN		1
227	40700-227	KNIFE REMOVAL		1
228	40700-228	CUTTERHEAD PIN		4
229	40700-229	CUTTERHEAD		1
230	40700-230	KNOB		2
232	40700-232	BLADE LOCKING BAR		2
234	40700-234	BLADE LOCKING BAR		2
238	40700-238	WEAR PLATE		1
239	40700-239	BALL BEARING		4
240	40700-240	BEARING RETAINER		2
241	40700-241	BEARING RETAINER		2

Ser#	Drawing	Description	Spec	qty
78		MOTOR		1
150		POWER CORD		1
155	N030698	SWITCH BOX		1
157		SWITCH PLATE		1
158	1343923	SCREW	3/16"*3/8"L	4
159		SWITCH		1
161		AIR BLOCK		1
162	N030701	AIR BOX		1
163	1343926	AIR FAN		1
164	1343927	SCREW	M5*16L	3
166	1343928	MOTOR COVER		1
167	1343923	SCREW	M5*8L	1
168	1343920A	GROUDING		1
169	1320101	WASHER		1
170	1343929	WASHER		1
171	9.2004E+11	BALL BEARING		2
172	1343930	RATOR		1
174	1343943A	STATOR		1
175	1343932	SCREW	M4.80*70	2
177	1343932	MOTOR COVER		1
178	1343936	BRUSH CAP		2
179	1343935	BRUSH		2
180	1343934	BRUSH HOLDER		2
181	1246008	SCREW	M5*12	2
182	1246195	C-RING		1



2

YEAR

WARRANTY

WARRANTY

1. WARRANTY

- (a) We warrant that this **carbatec** product will be free from defects caused by faulty workmanship or faulty materials for a period of **2 years from date of sale**.
- (b) This warranty is in addition to other rights and remedies you may have under a law in relation to the goods.
- (c) This warranty does not apply in any of the following cases:
 - (i) defects arising from:
 - (1) fair wear and tear;
 - (2) corrosive atmosphere;
 - (3) damage or injury caused by deliberate act, lack of care or failure to comply with the recommended care and maintenance for the goods;
 - (4) improper use of the goods;
 - (5) alterations or repairs (not made by us) to the goods;
 - (ii) defects arising from an event outside of our control such as fire, flood, earthquake or other natural calamity, motor vehicle or other accident, strike, civil unrest, terrorism or war;
 - (iii) to accessory items such as after-market jigs, accessories or other items which are not sold or serviced by us and which are not sold with or were not included with the main unit purchased; or
 - (iv) to wearable parts such as drive belts/shafts, bearings, bandsaw tyres, motor brushes, blades or abrasive belts/discs or other cutting or machining implements.
 - (v) damage caused to any electrical component, where connected to a power supply outside the country for which it was designed (namely Australia or New Zealand).
- (d) If this warranty applies and you have complied with the procedure below for making a claim, we will, at our election, either repair the goods (or those parts of the goods recognised as defective) or will provide a replacement within a reasonable time at our expense.
- (e) If this warranty applies, the procedure for making a claim is:
 - (i) you must contact us by email;
 - (ii) you must include in the email the following information:
 - (1) a copy of the order or receipt for the goods;
 - (2) the serial or batch number printed on the machinery manufacturing plate; and
 - (3) a detailed description of the fault and how and when it arose; and
 - (iii) if the fault is a type covered by this warranty, we will then make arrangements with you for the return of the goods to us (for repair or replacement) at our cost using our transport providers or we may decide to attend at your premises to repair or replace the goods.
- (f) Our liability (and that of our resellers) under this warranty is wholly limited to repair or replacement of the goods (or those parts of the goods recognised as defective) in accordance with the procedure above and you have no right to other compensation, costs or damages under this warranty. But this does not mean that you may not have other rights under a law in relation to the goods.
- (g) If following our inspection of goods returned by you under this warranty it is found that this warranty does not apply and you are not otherwise entitled to repair or replacement by us, you must, if requested by us, reimburse our costs including parts, labour and freight.
- (h) This warranty is not transferable and only the person who purchased the goods may make a claim.
- (i) Where the goods have been exported outside Australia or New Zealand, the Company may not require the Purchaser to return any allegedly faulty or defective Product for evaluation. However, the Company has the right to request the return for evaluation at purchasers cost.

2. STATUTORY NOTICE

Our goods come with guarantees that cannot be excluded under the Australian Consumer Law. You are entitled to a replacement or refund for a major failure and for compensation for any other reasonably foreseeable loss or damage. You are also entitled to have the goods repaired or replaced if the goods fail to be of acceptable quality and the failure does not amount to a major failure.

3. CONTACT DETAILS

Carbatec Pty Ltd ABN 84 010 706 242

info@carbatec.com.au | Phone 1800 658 111 | www.carbatec.com.au

128 Ingleston Road, Wakerley, QLD Australia 4154

Carbatec Pty Ltd
ABN 84 010 706 242

info@carbatec.com.au

Phone: 1800 658 111
128 Ingleston Road, Wakerley
Queensland Australia 4154

www.carbatec.com.au

carbatec